

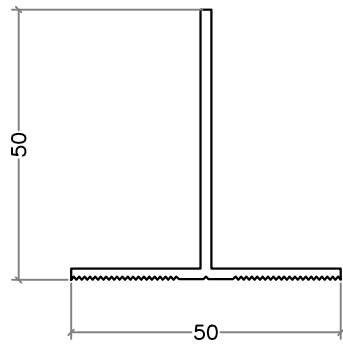

code	profile	profile features	code	profile	profile features
------	---------	------------------	------	---------	------------------

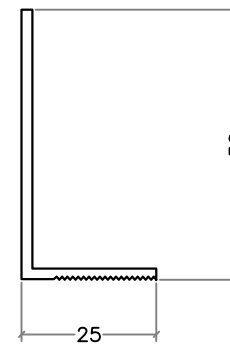

T Profile (50x50)



L Profile (25x50)

TP01

colour : ral

LP01

colour : ral

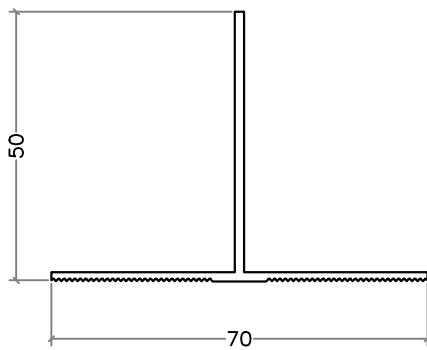

T Profile (70x50)

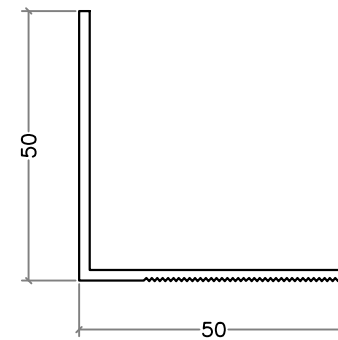

L Profile (50x50)

TP02

colour : ral

LP02

colour : ral

SECTION

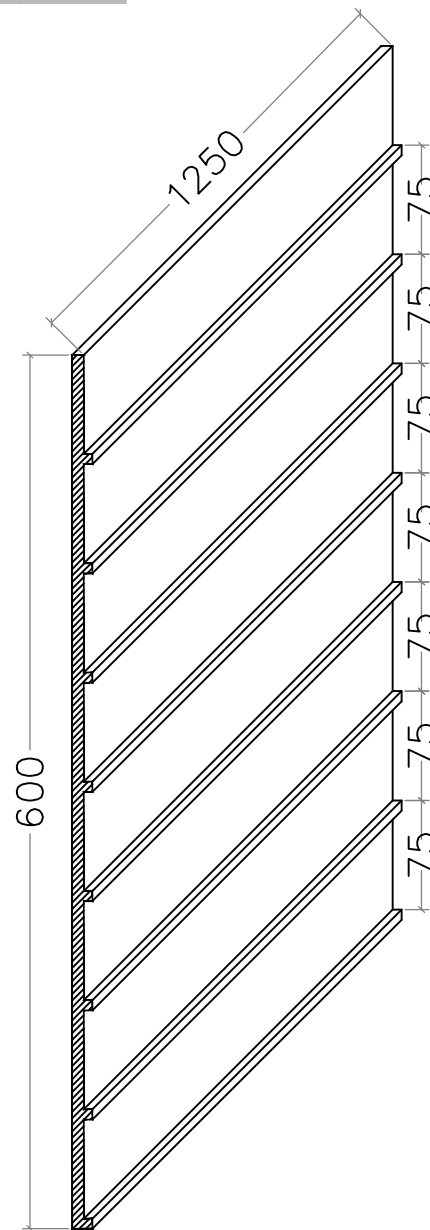
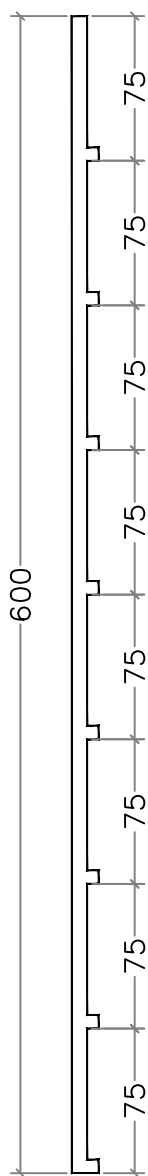



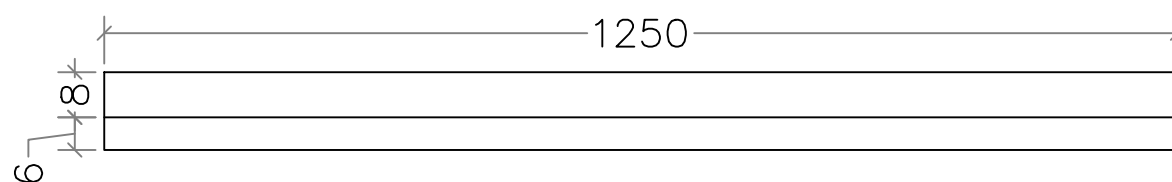



GRC CHANNEL (PANEL)

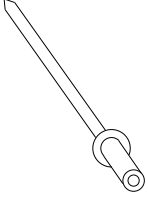
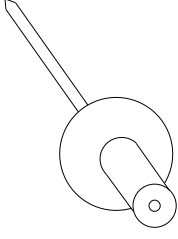

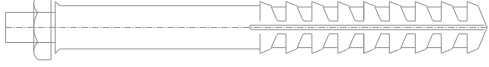
PLAN



code	profile	profile features	code	profile	profile features
	 4x10 Rivet	 4,8x25 Rivet (Supply by requested RAL code)		 Steel Dowel	
				 Plastic Dowel	
	 3,9x19 YHB (M.U.V)	 3,9x19 YSB (M.U.V)	 4,8x16 YSB (M.U.V)	 AKB 5,5x25 (M.U.V)	

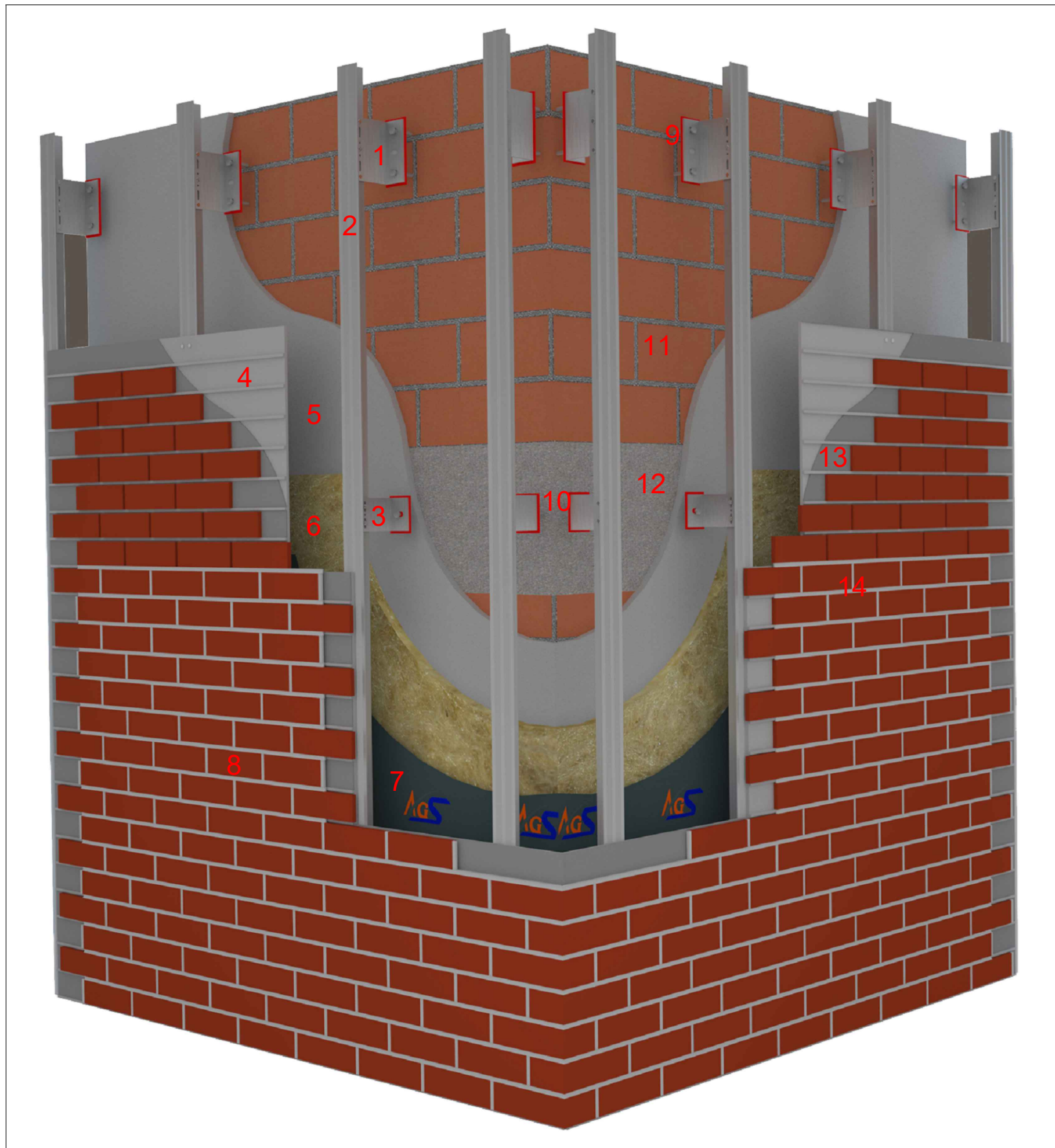

1. IZOFIX SUPPORT BRACKET
2. T PROFILE
3. IZOFIX MAIN BRACKET
4. GRC CHANNEL
5. PLASTER
6. THERMAL INSULATION
7. WATERPROOF MEMBRANE
8. BRICK SLAB
9. PLASTIC DOWEL
10. STEEL DOWEL
11. BRICK BLOCK
12. CONCRETE BEAM
13. FLEX ADHESIVE
14. FLEX JOINT FILLER

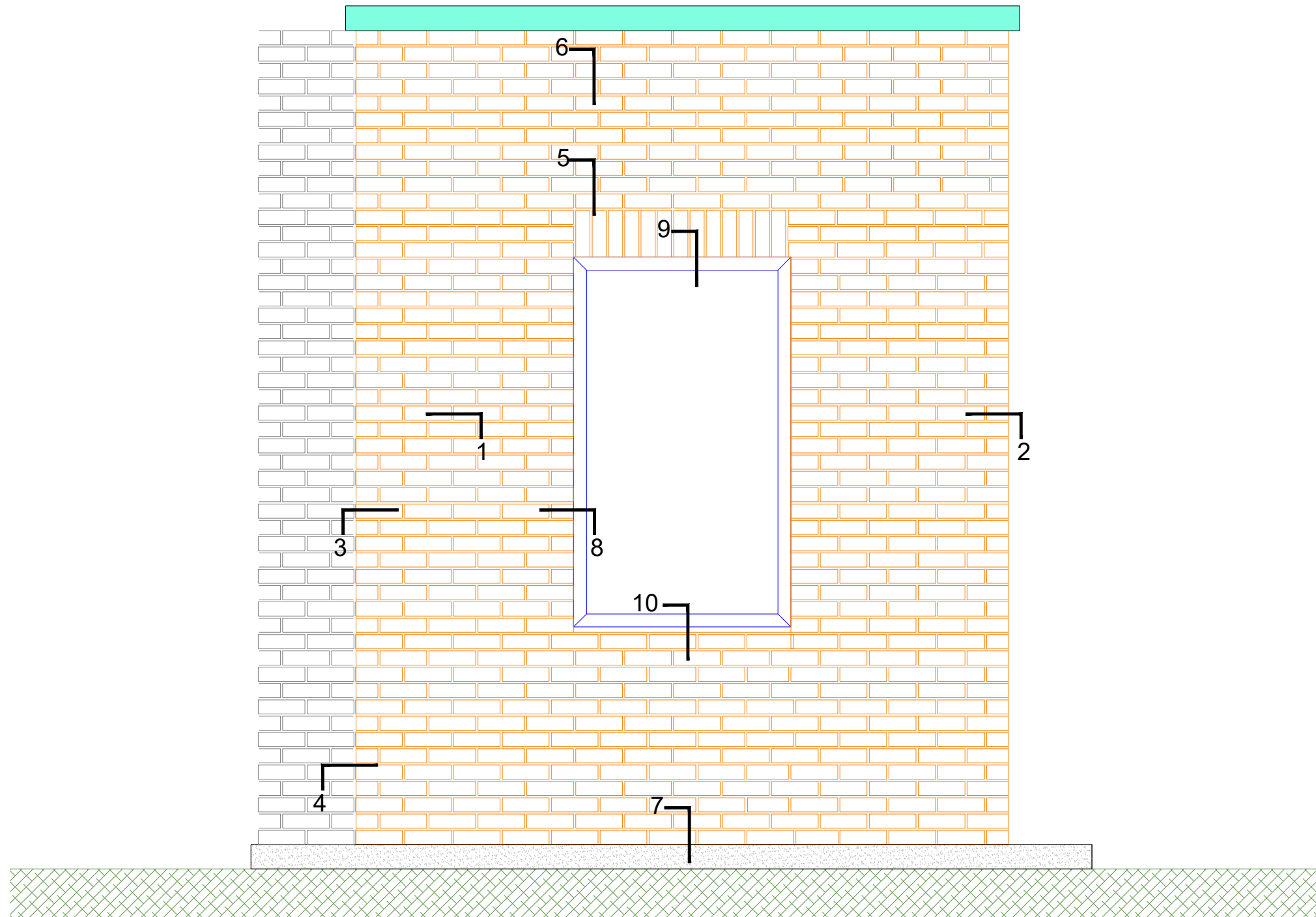

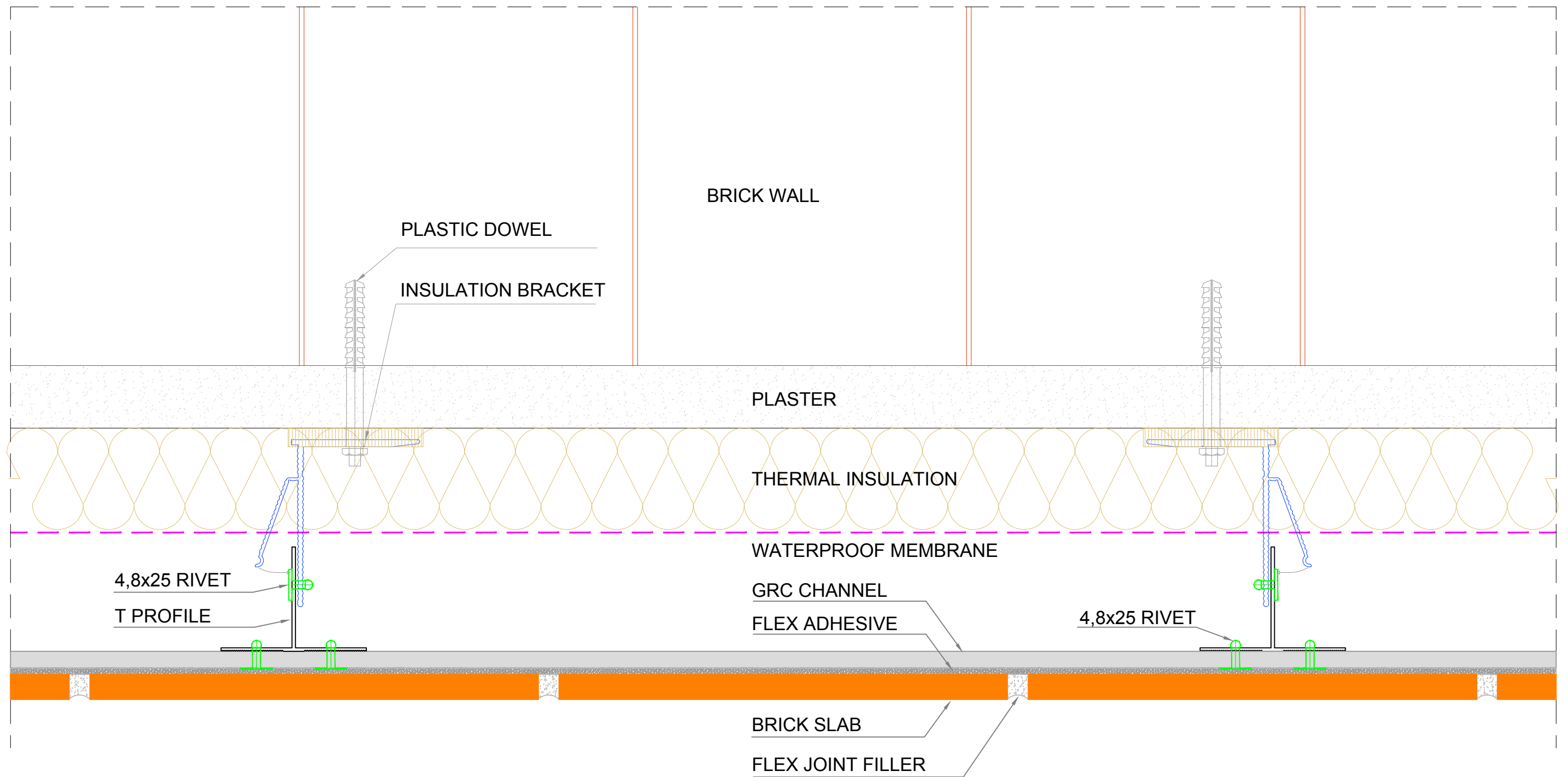

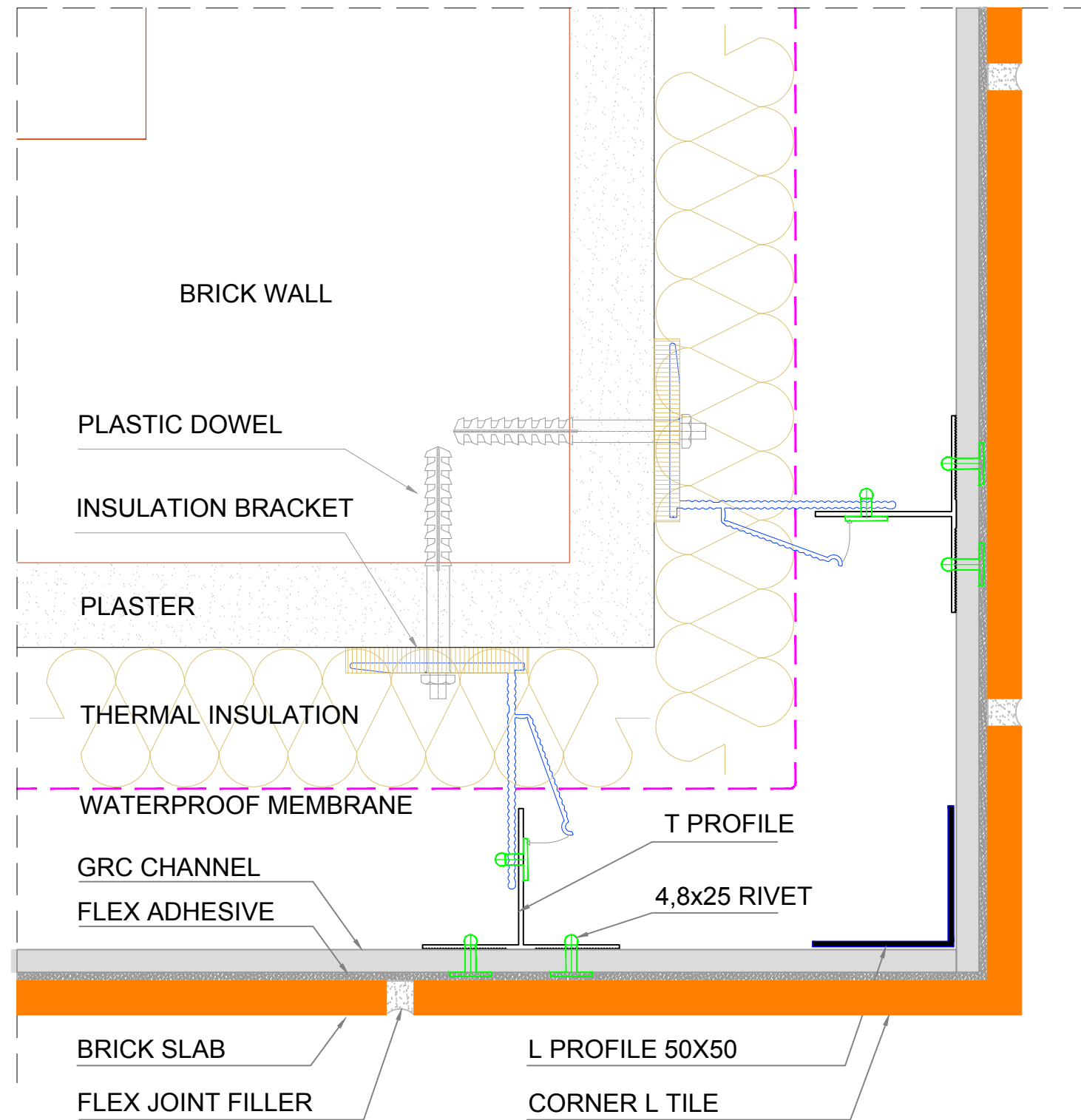

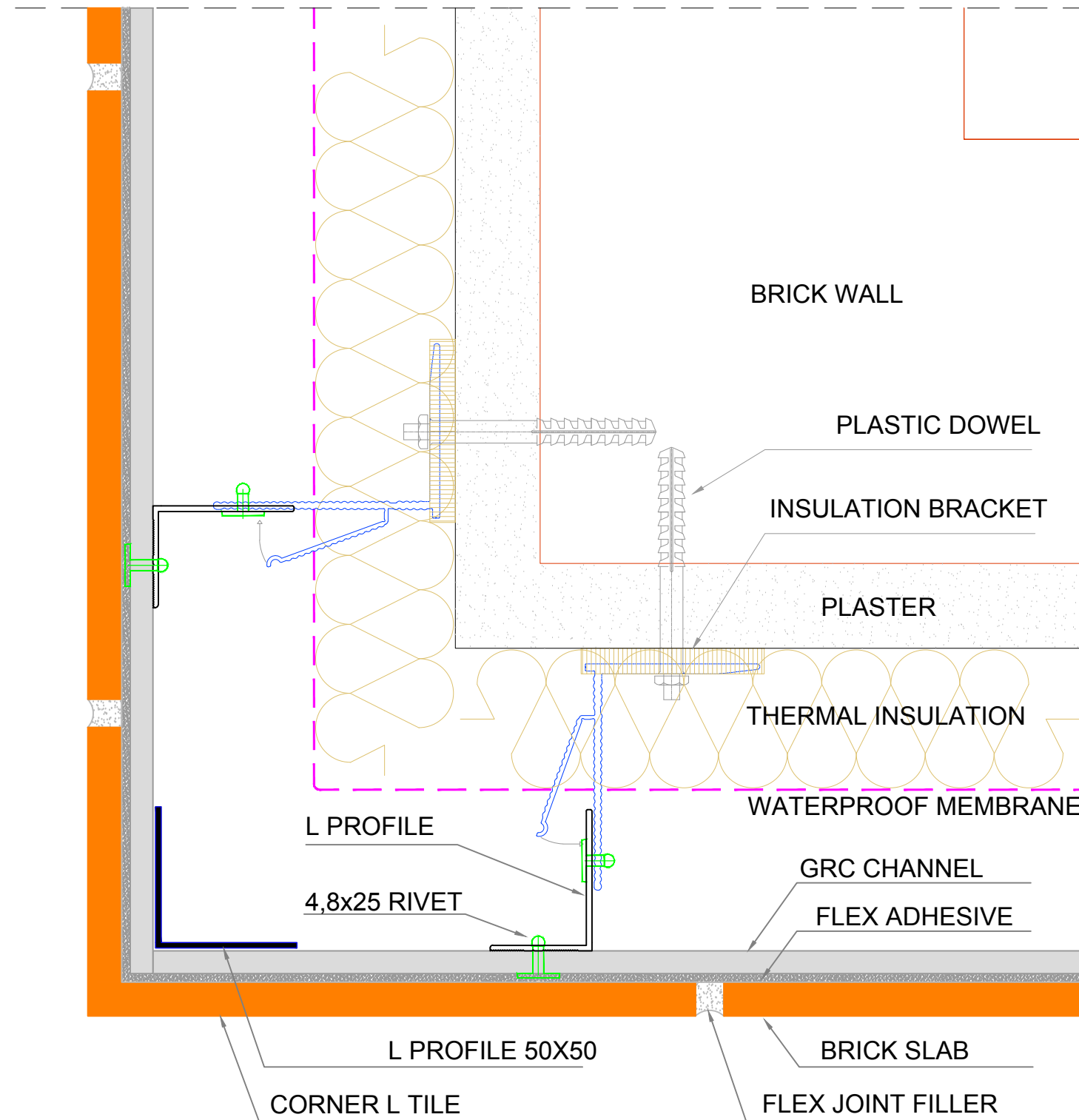

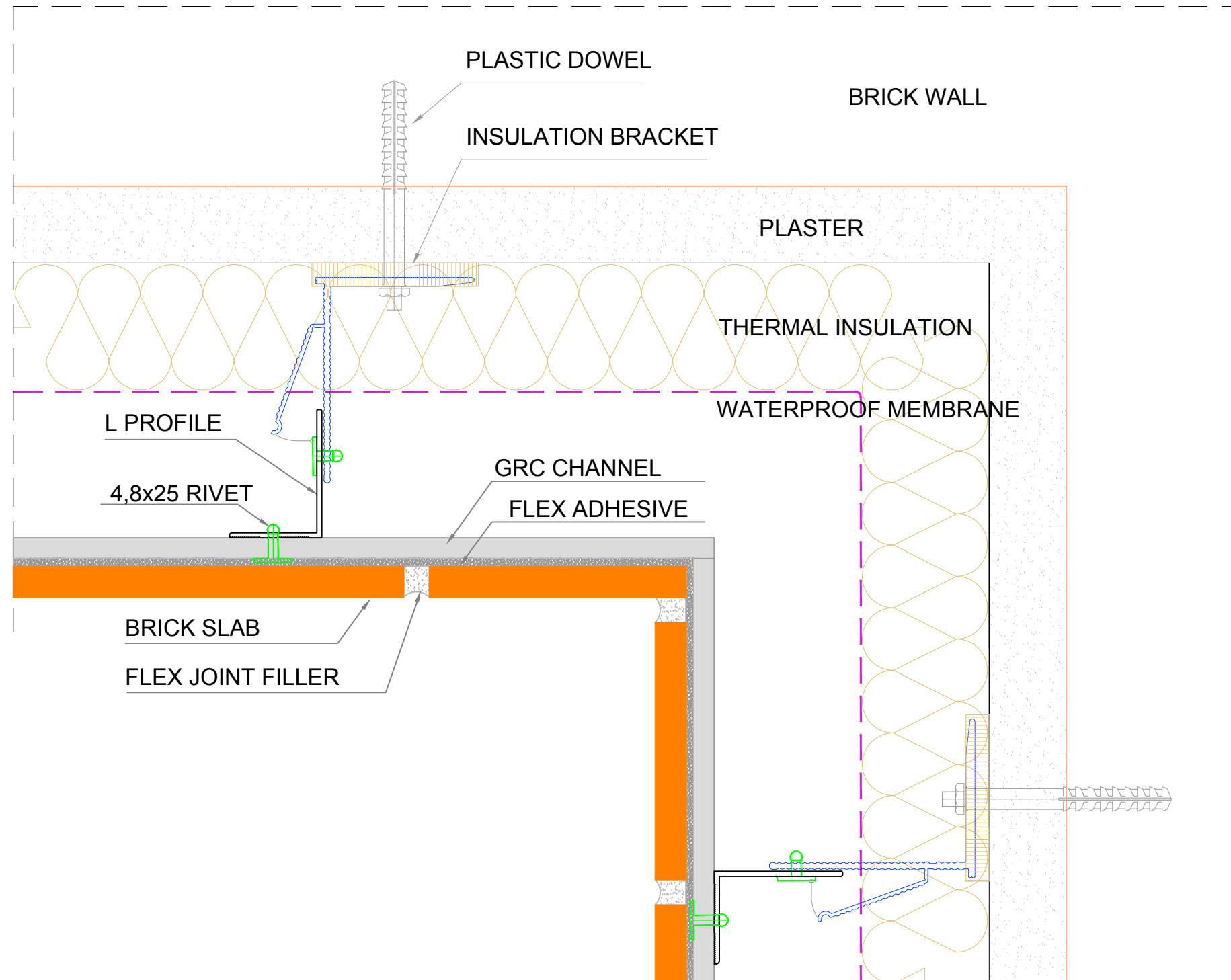

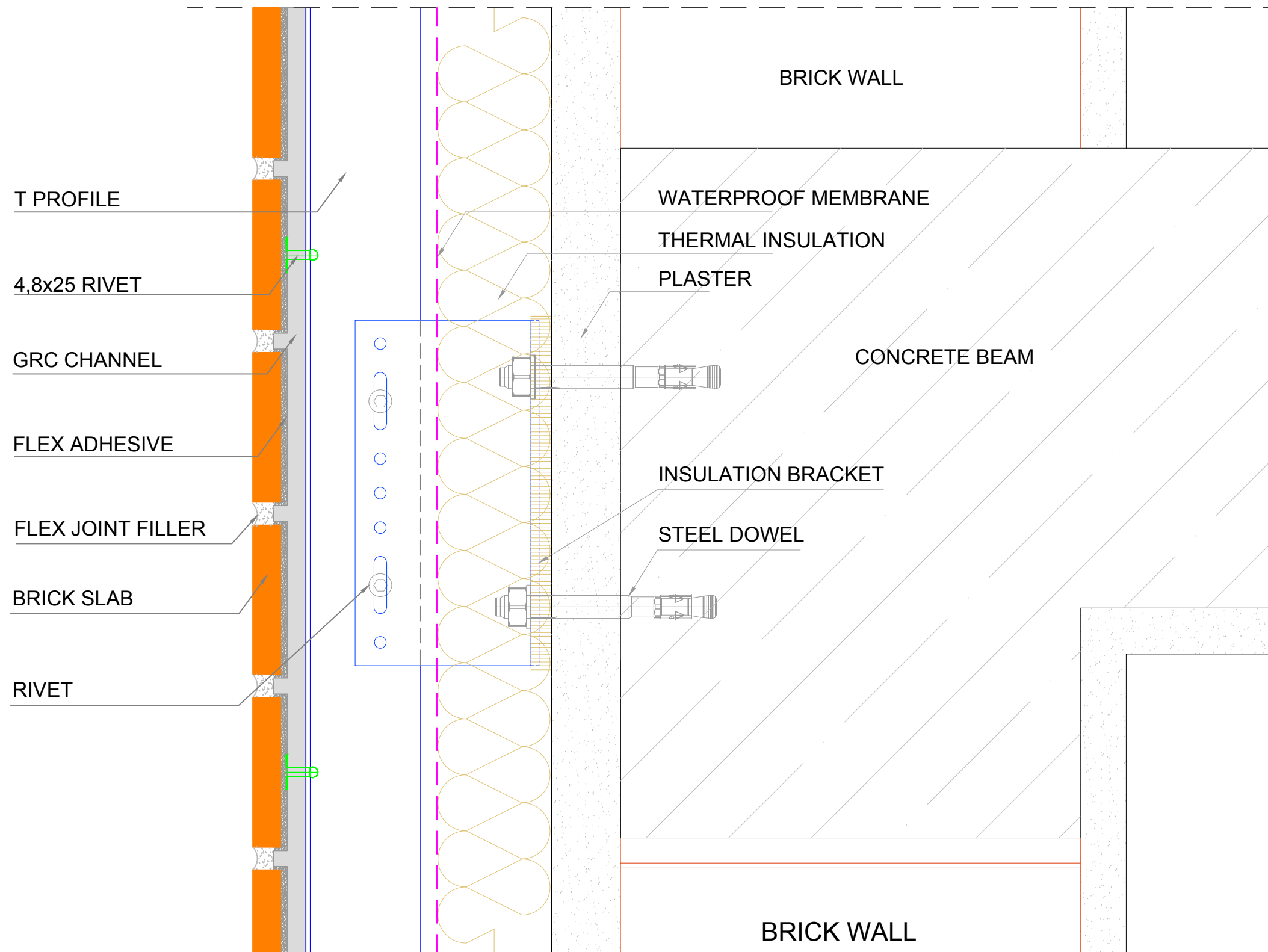

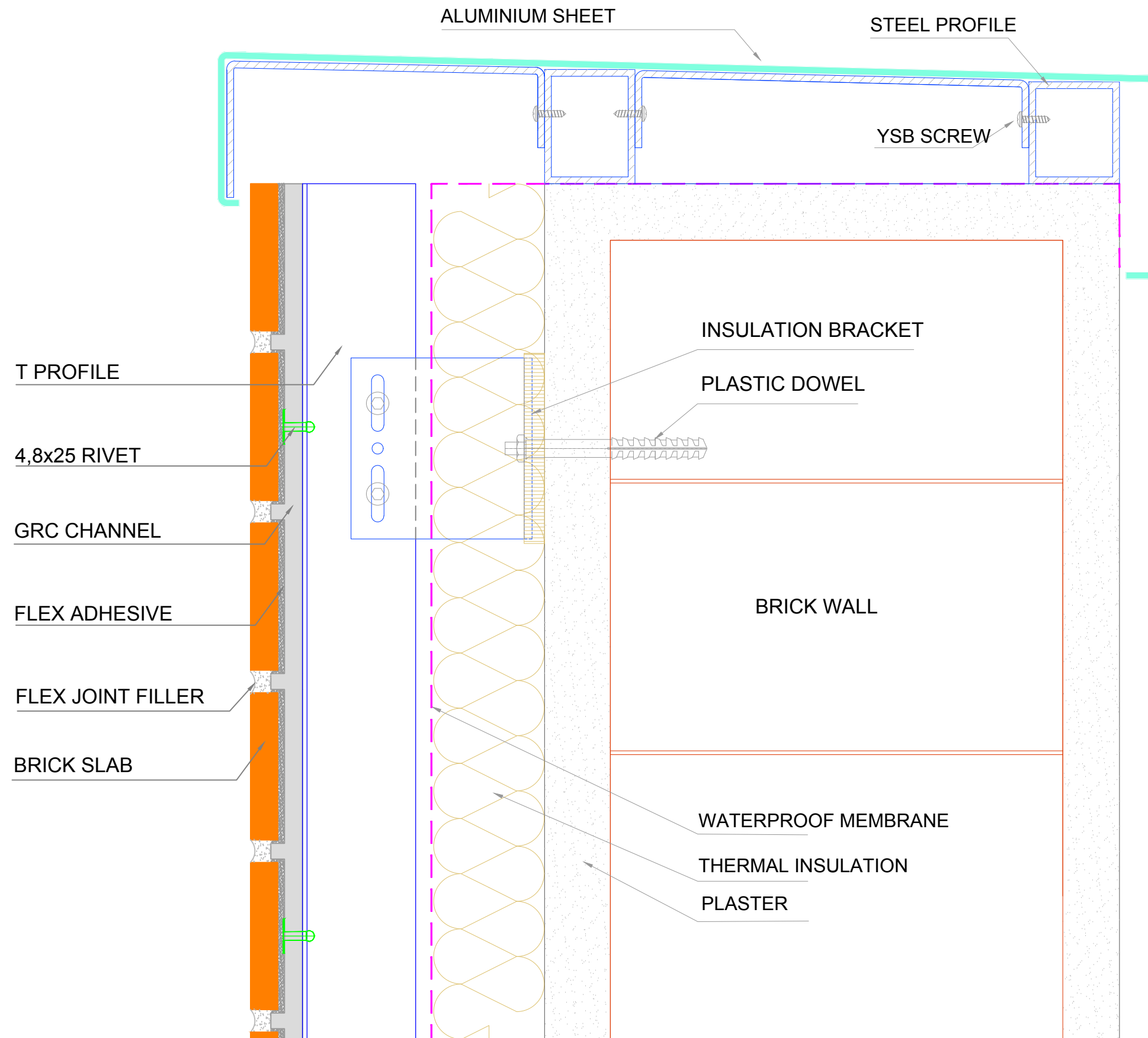

DETAIL 6

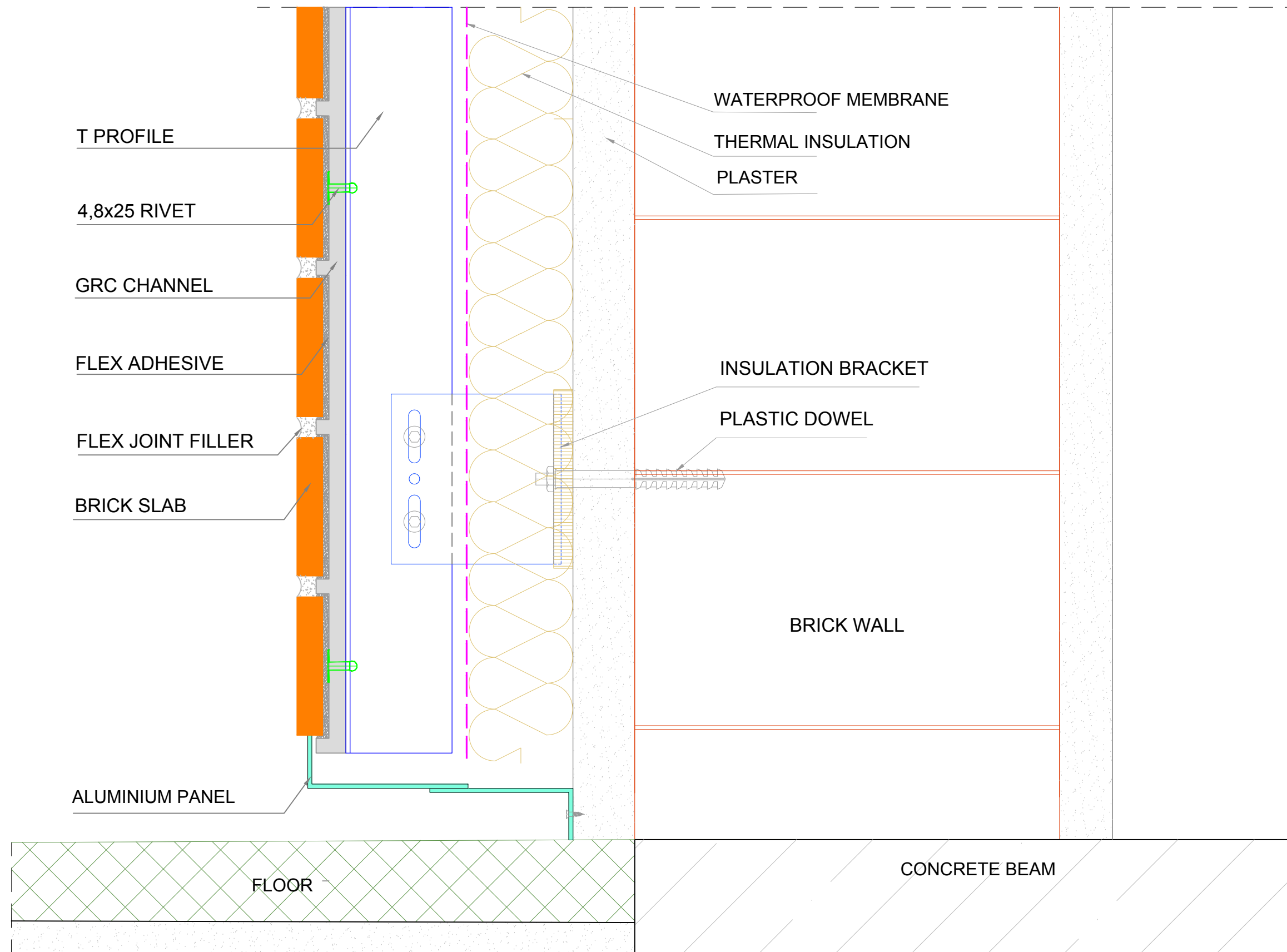

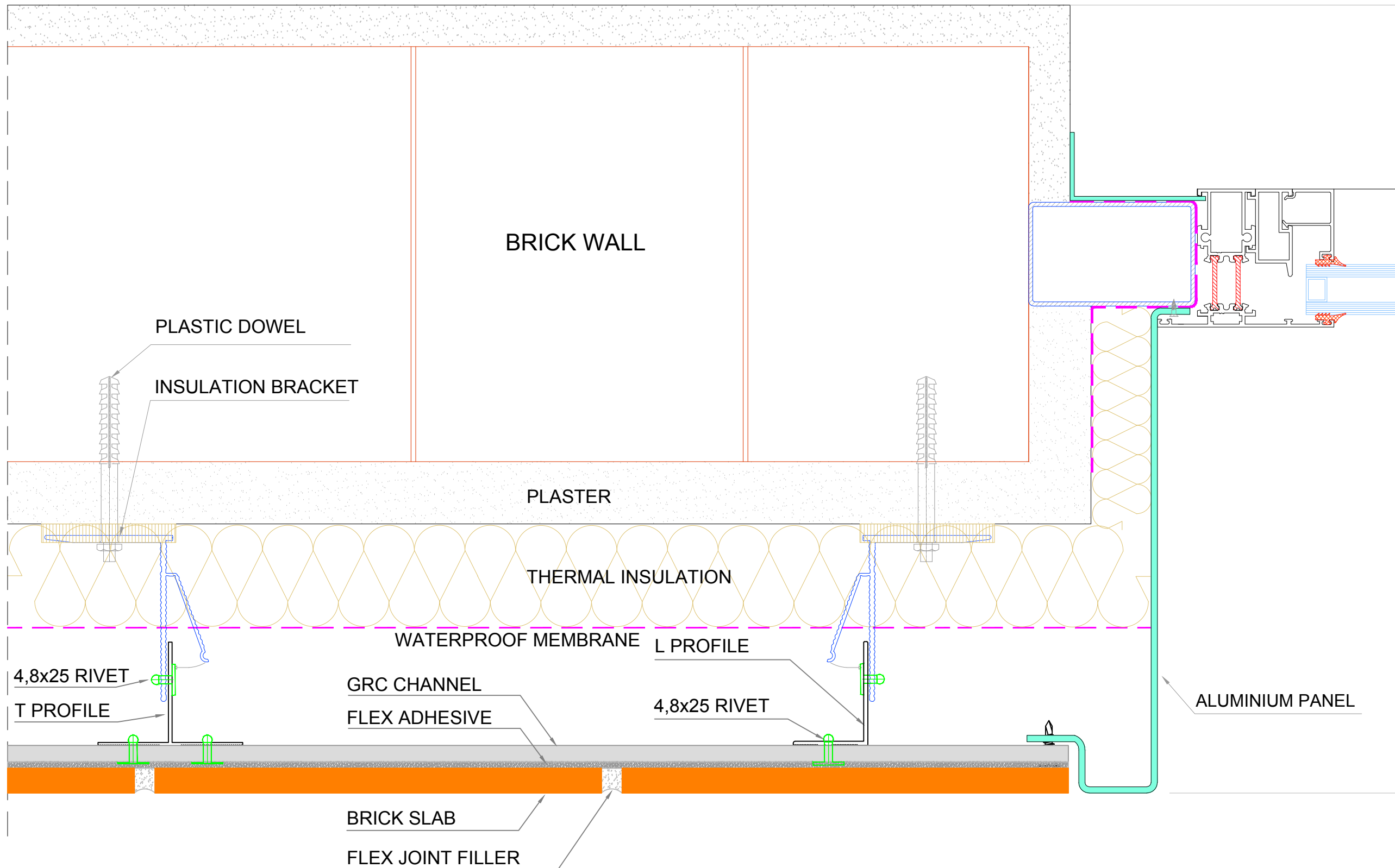

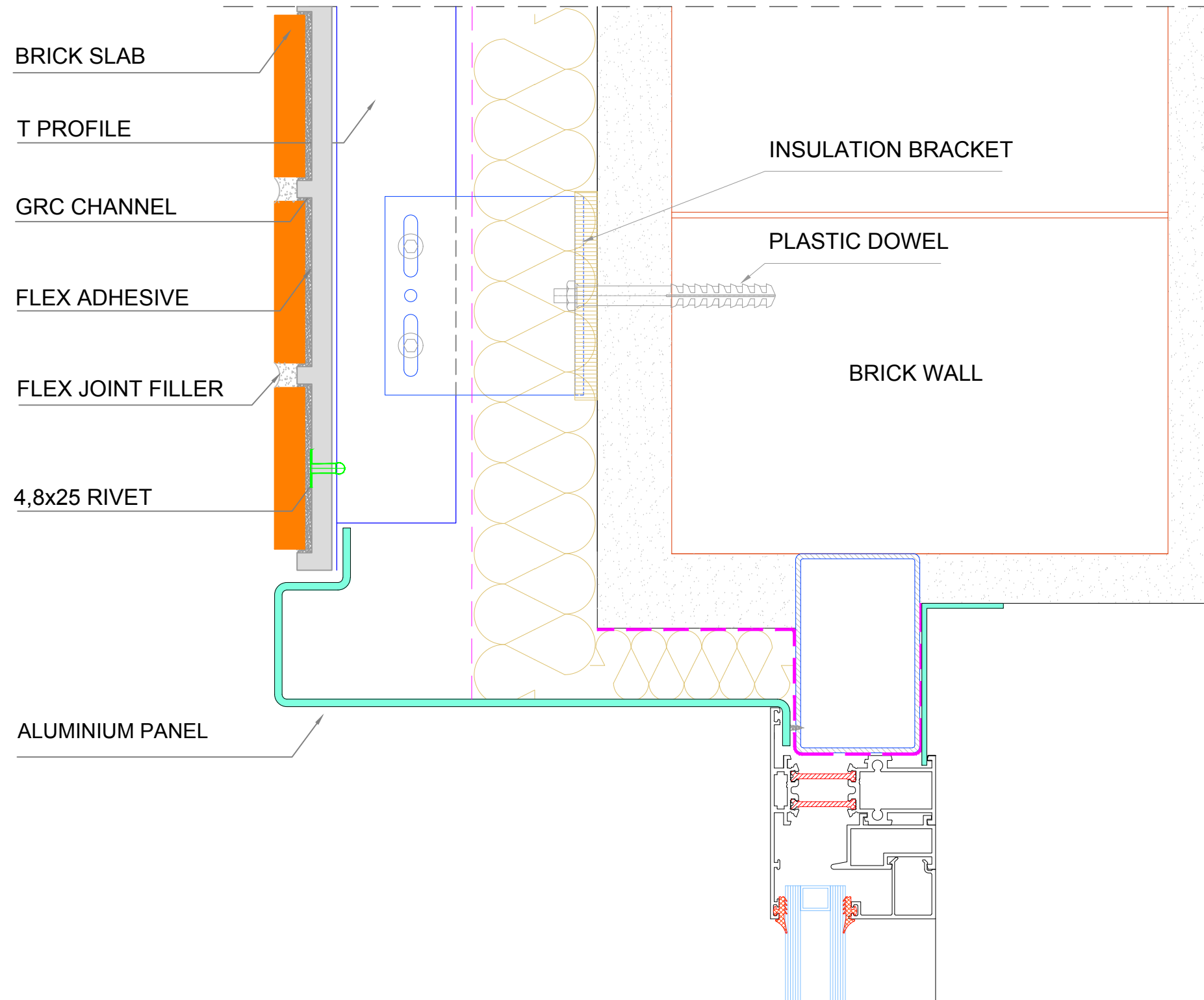

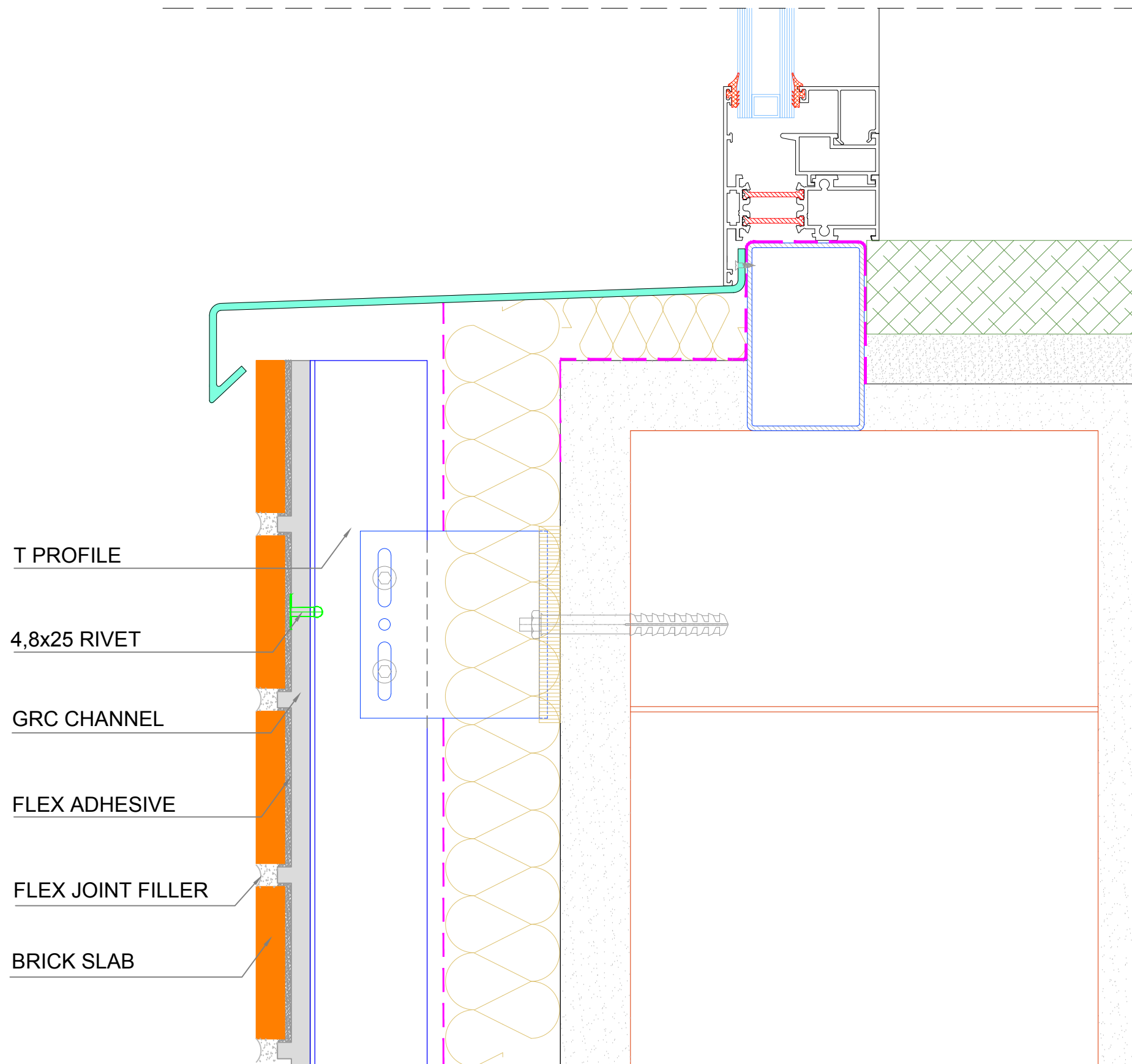

DETAIL 10

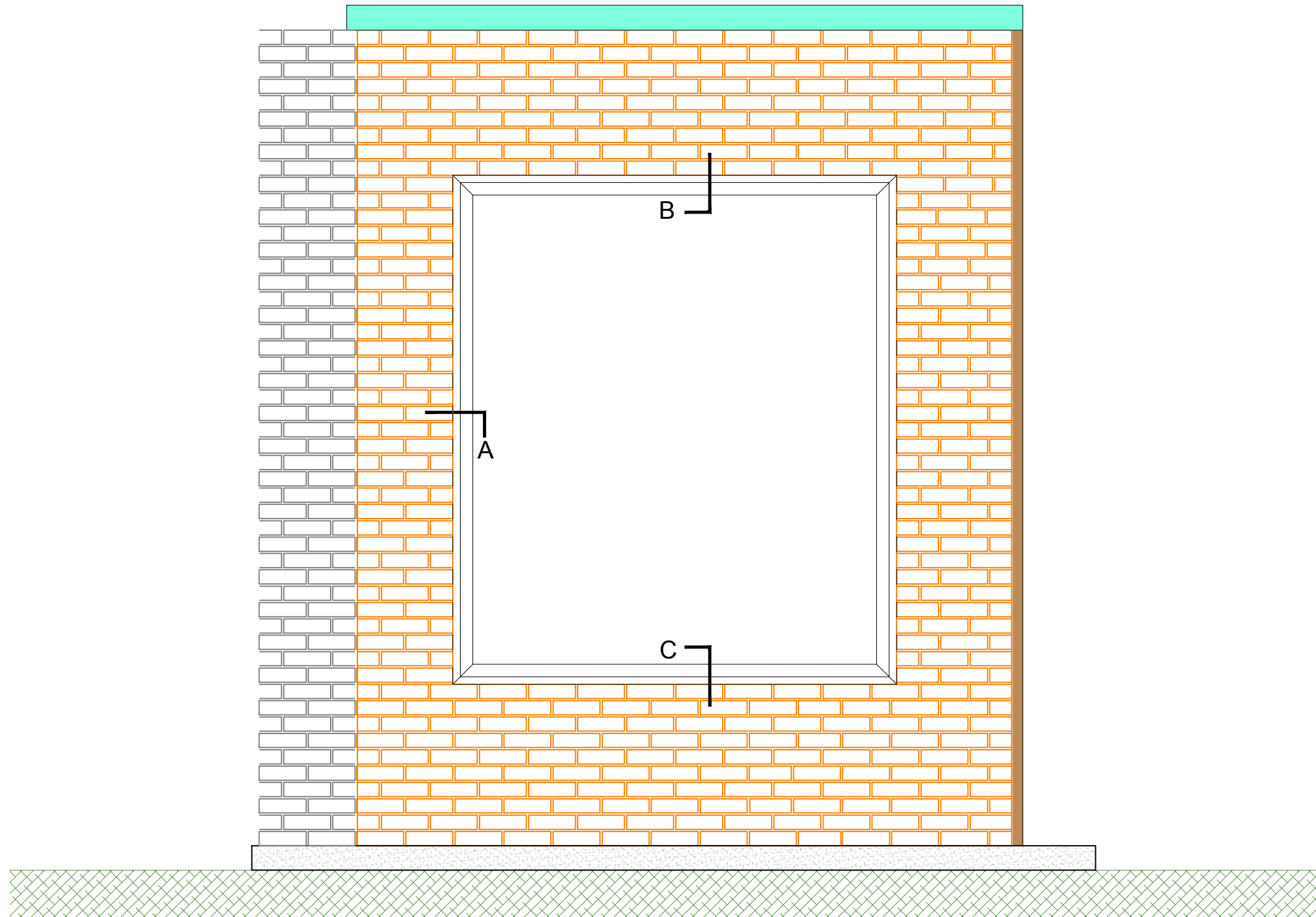

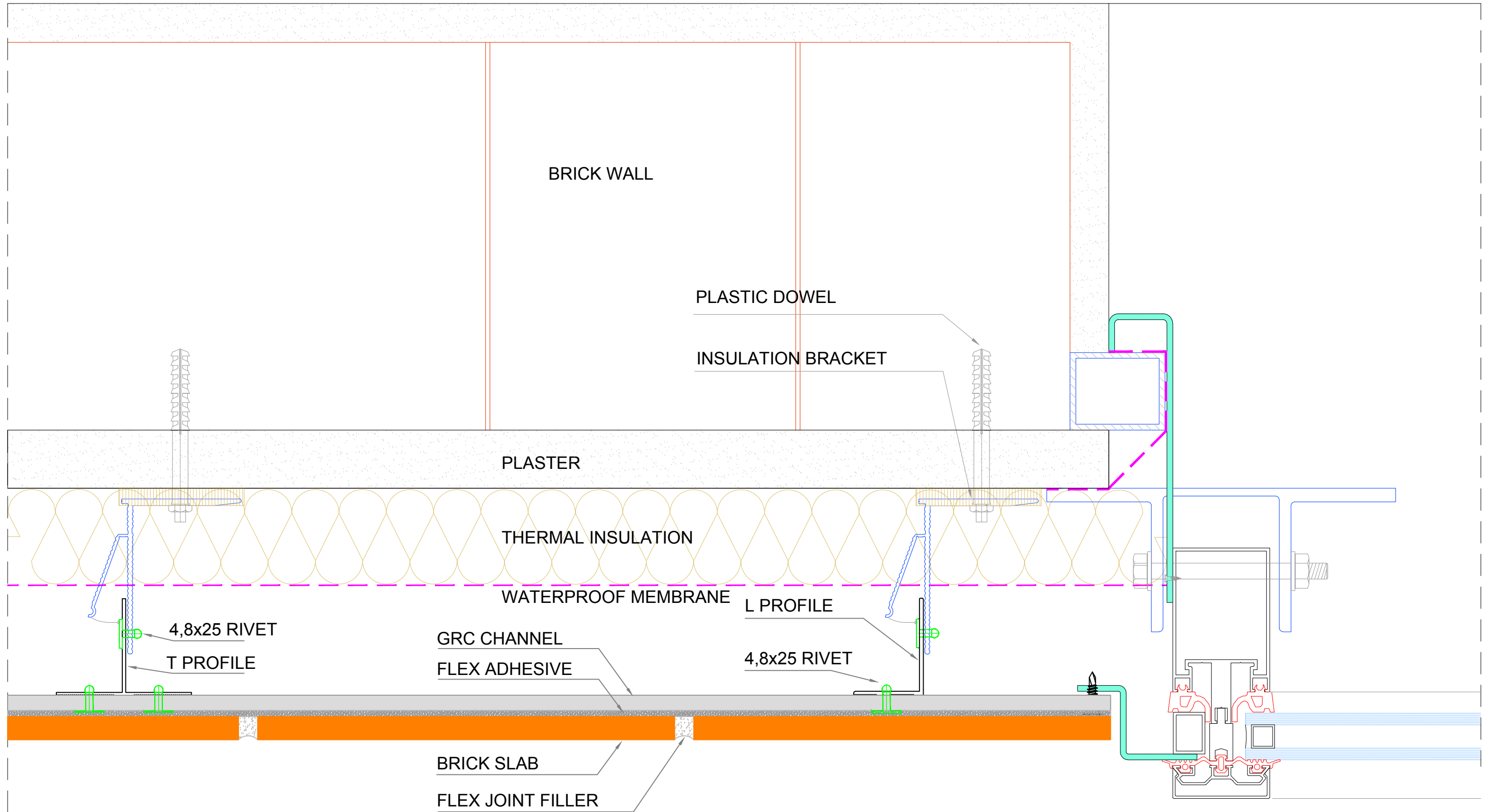

DETAIL A

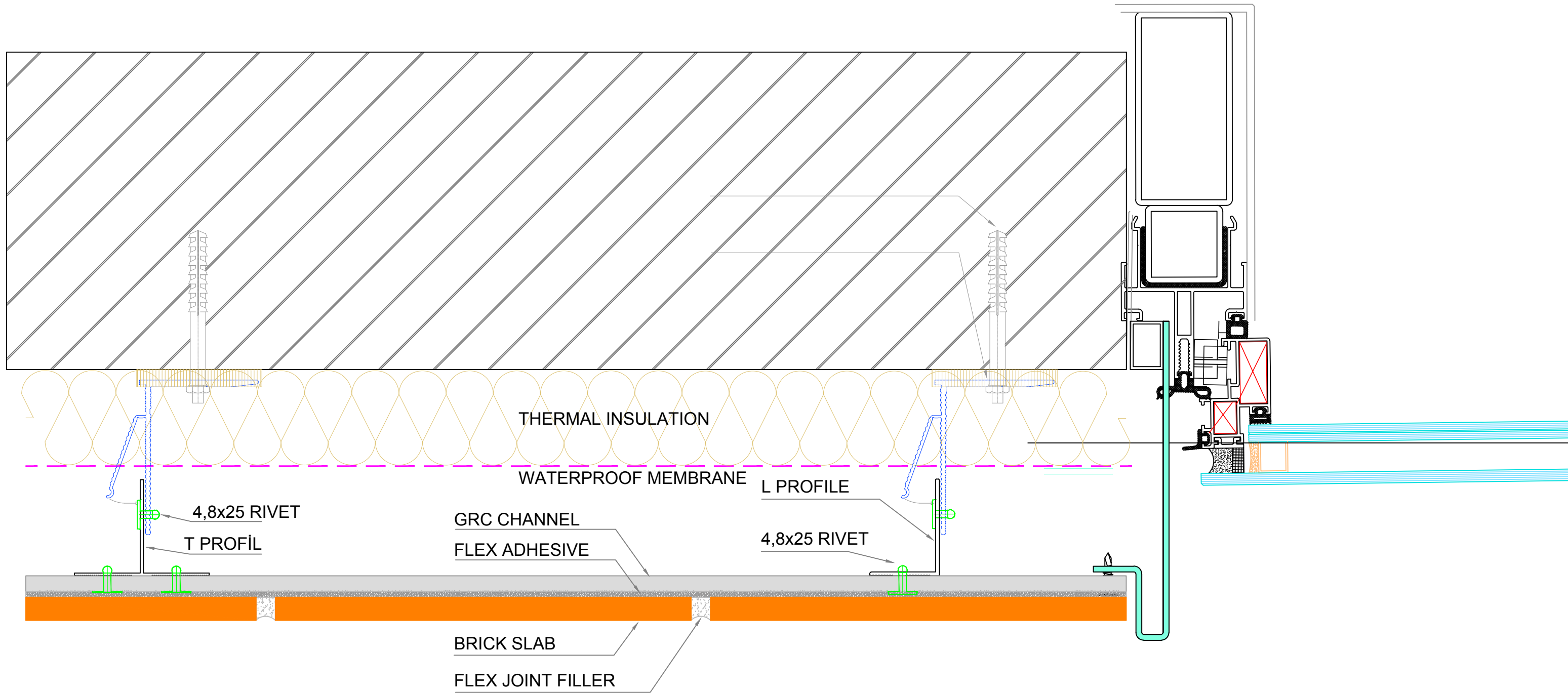

DETAIL A ALTERNATIVE

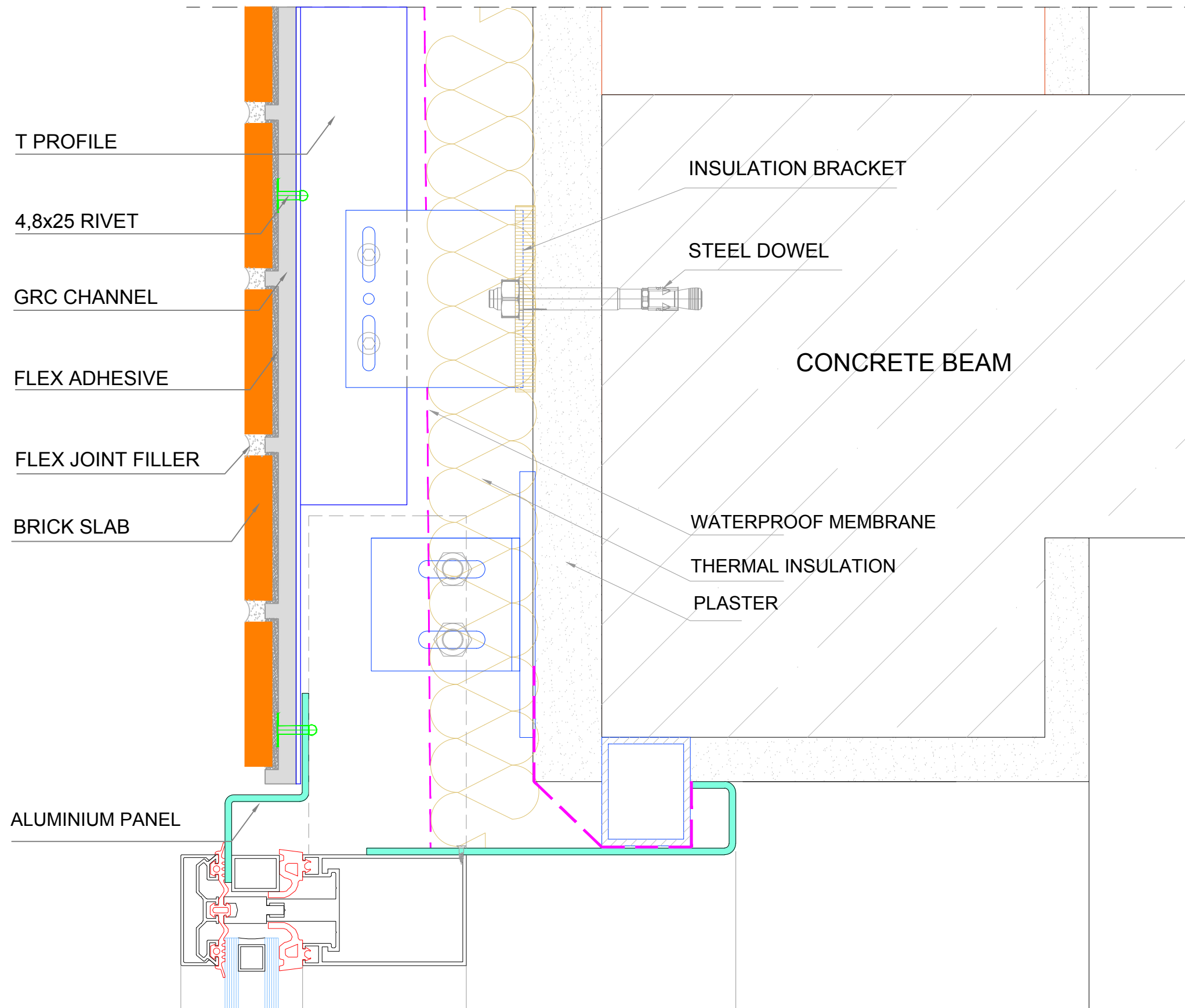

DETAIL B

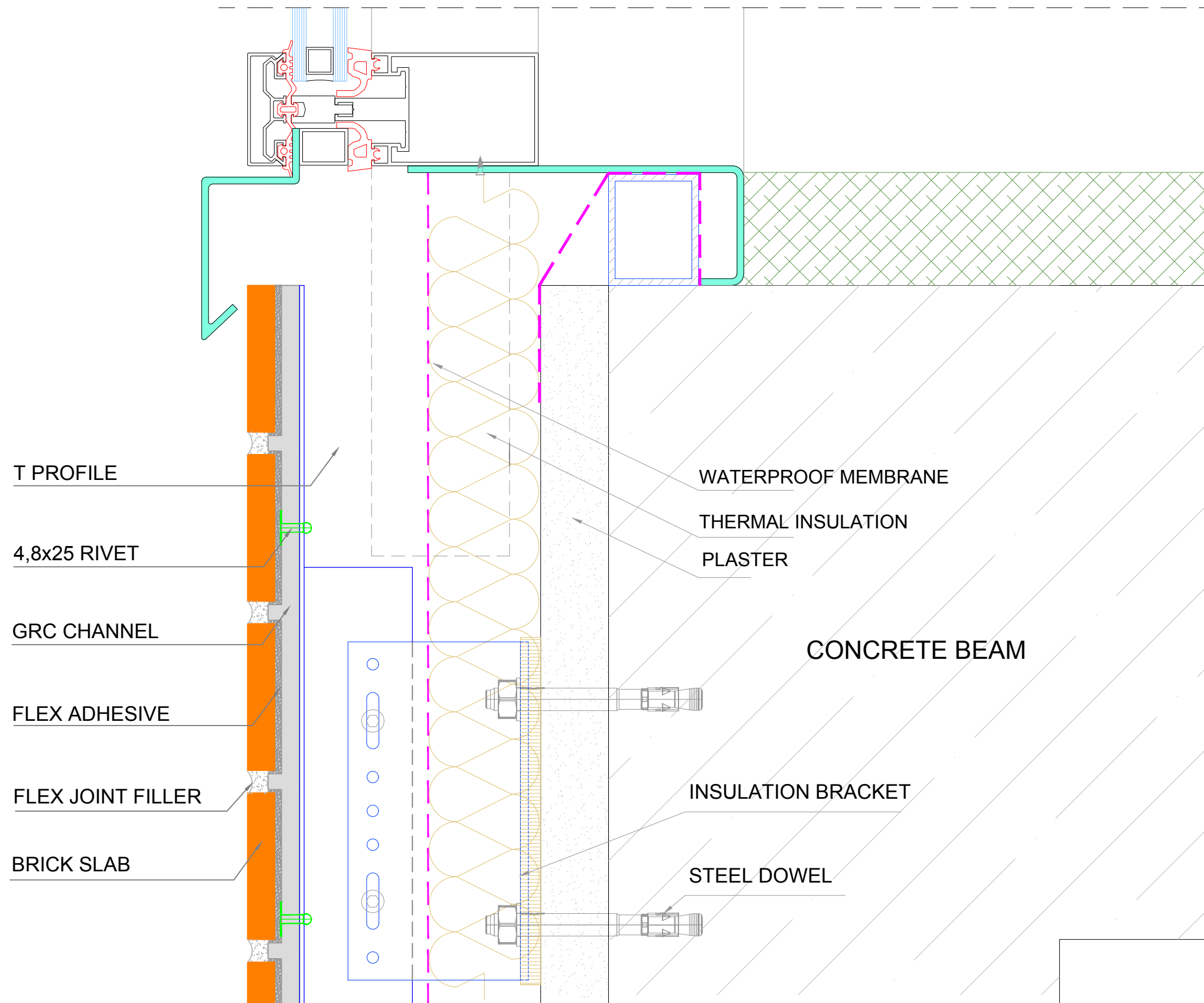

DETAIL C